

NUF4105FC

4 Channel EMI Pi-Filter Array with ESD Protection +4 ESD Diodes

This device is a 4 channel EMI filter array for data lines. Greater than -40 dB attenuation is obtained at frequencies from 800 MHz to 2.2 GHz. It also offers ESD protection – clamping transients from static discharges to protect delicate data line circuitry. It is offered in 300 μm and 350 μm solder spheres.

Features

- EMI Filtering and ESD Protection for Data Lines
- Integration of 26 Discretes Offers Cost and Space Savings
- Exceeds IEC61000-4-2 (Level 4) Specifications
- Low Profile Flip-Chip Packaging
- MSL 1
- 300 μm Solder Spheres (NUF4105), Case 499D

Typical Applications

- EMI Filtering and ESD Protection for Data Lines
- Cell Phones
- Handheld Portables
- Notebook Computers
- MP3 Players

MAXIMUM RATINGS ($T_A = 25^\circ\text{C}$)

Rating	Symbol	Value	Unit
ESD Discharge IEC61000-4-2, – Air Discharge – Contact Discharge Human Body Model	V_{PP}	30 30 16	kV
DC Power per Resistor	P_R	100	mW
DC Power per Package	P_T	400	mW
Junction Temperature	T_J	150	$^\circ\text{C}$
Operating Temperature Range	T_{Op}	-40 to +85	$^\circ\text{C}$
Storage Temperature Range	T_{stg}	-55 to +150	$^\circ\text{C}$

Maximum ratings are those values beyond which device damage can occur. Maximum ratings applied to the device are individual stress limit values (not normal operating conditions) and are not valid simultaneously. If these limits are exceeded, device functional operation is not implied, damage may occur and reliability may be affected.



ON Semiconductor®

<http://onsemi.com>

CIRCUIT DESCRIPTION

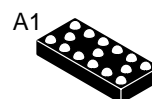
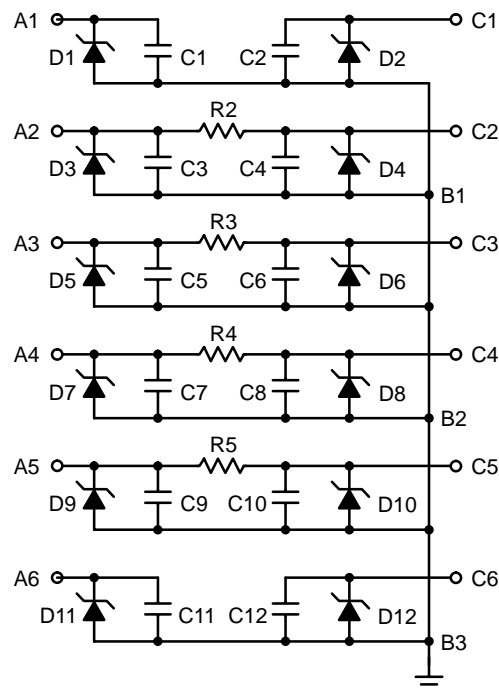

**FLIP-CHIP
CASE 499D
300 μm Bumps**

DEVICE MARKING

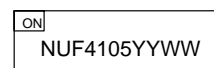

YY = Year
WW = Work Week

ORDERING INFORMATION

Device	Package	Shipping†
NUF4105FCT1	Flip-Chip	3000/Tape & Reel

†For information on tape and reel specifications, including part orientation and tape sizes, please refer to our Tape and Reel Packaging Specification Brochure, BRD8011/D.

NUF4105FC

ELECTRICAL CHARACTERISTICS ($T_A = 25^\circ\text{C}$ unless otherwise noted)

Symbol	Characteristic	Min	Typ	Max	Unit
V_{BR}	$I_Z = 10\text{ mA}$	6.0	7.0	8.0	V
I_R	$V_{RM} = 3.3\text{ V per line}$	–	–	0.1	μA
$R_{I/O}$	$I_R = 20\text{ mA}$	80	100	120	Ω
C_{line}	$V_R = 2.5\text{ V}, f = 1.0\text{ MHz}$ (Note 1)	–	53	–	pF

1. Measured from input/output pins to ground.

TYPICAL PERFORMANCE CURVES

($T_A = 25^\circ\text{C}$ unless otherwise specified)

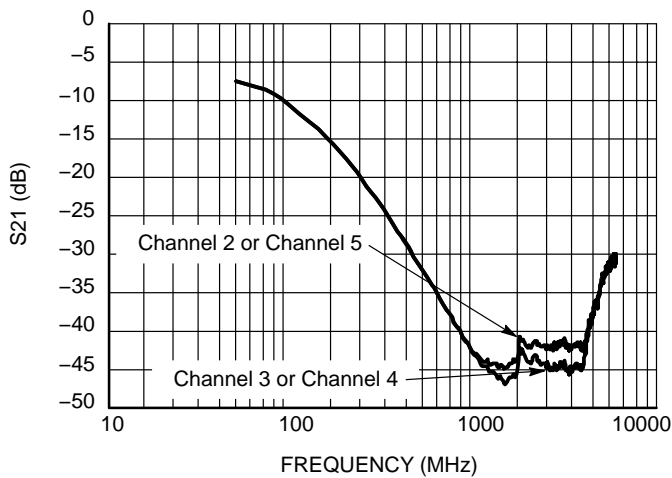

Figure 1. Insertion Loss Curve

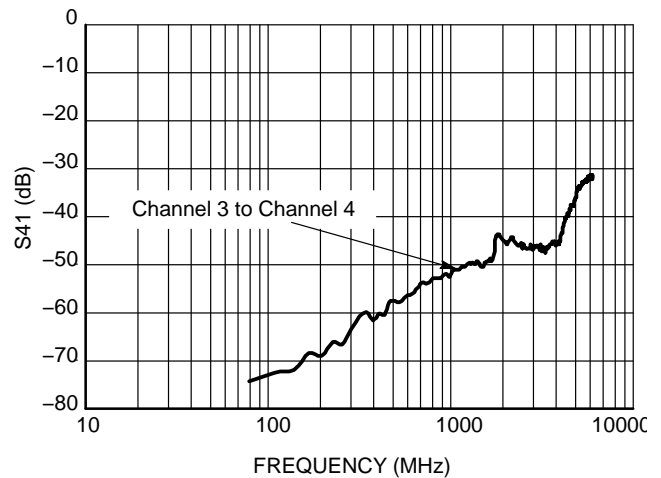

Figure 2. Analog Crosstalk Curve

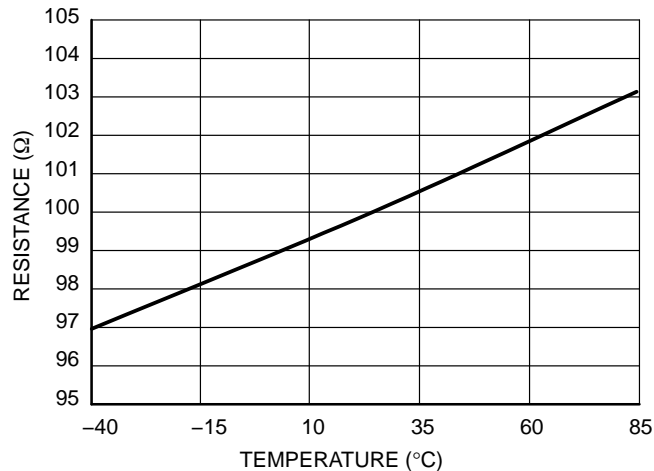

Figure 3. Resistance Over Temperature

NUF4105FC

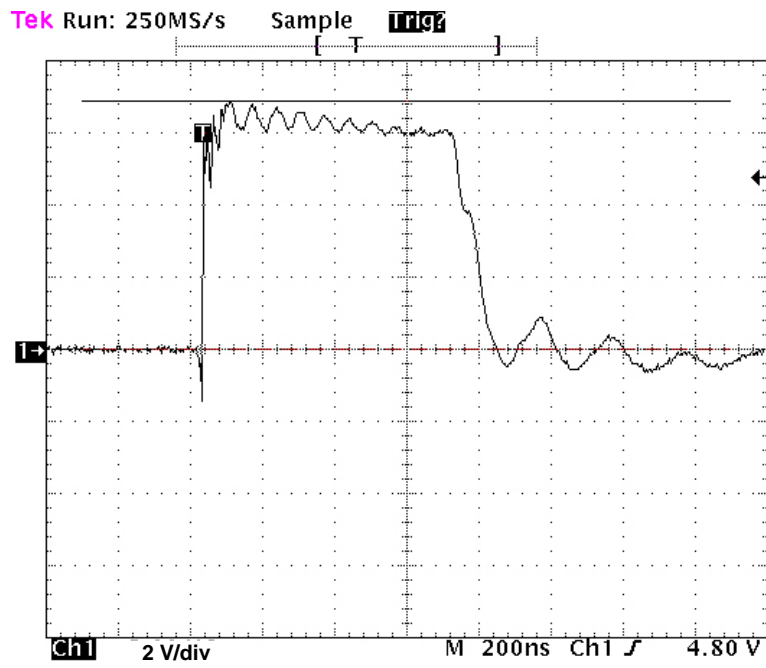

Figure 4. ESD Response for Human Body Model (+8.0 kV)

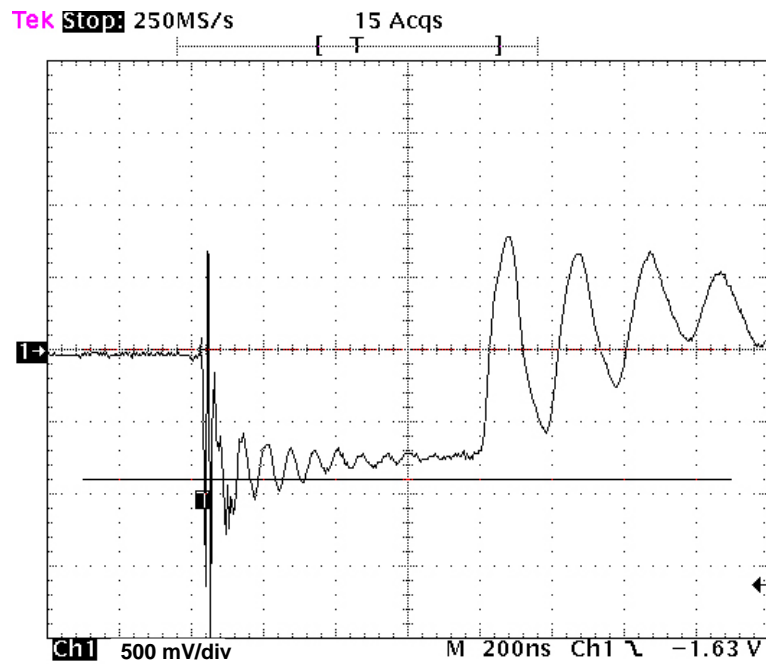

Figure 5. ESD Response for Human Body Model (-8.0 kV)

NUF4105FC

Printed Circuit Board Recommendations

Parameter	500 μm Pitch 300 or 350 μm Solder Ball
PCB Pad Size	250 μm +25 -0
Pad Shape	Round
Pad Type	NSMD
Solder Mask Opening	350 μm \pm 25
Solder Stencil Thickness	125 μm
Stencil Aperture	250 x 250 μm sq.
Solder Flux Ratio	50/50
Solder Paste Type	No Clean Type 3 or Finer
Trace Finish	OSP Cu
Trace Width	150 μm Max

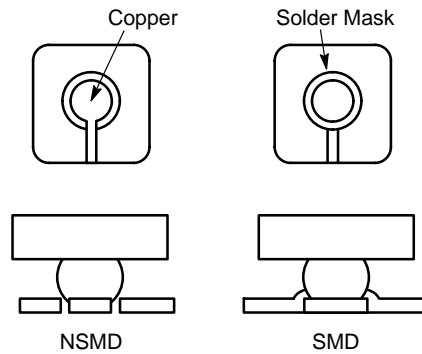

Figure 6. Solder Mask versus Non-Solder Mask Definition

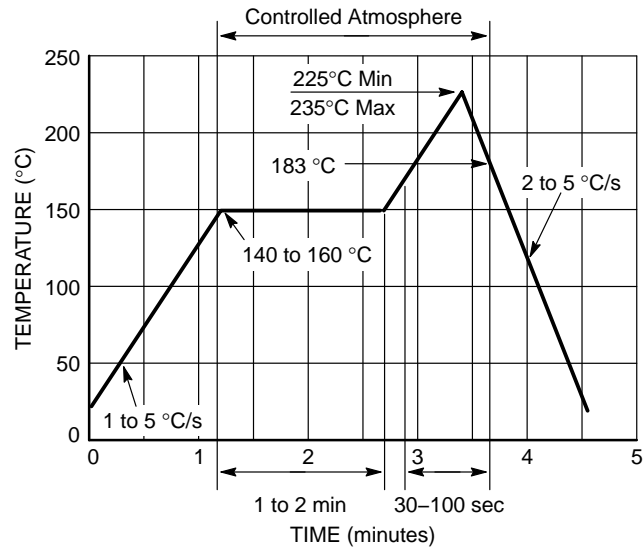
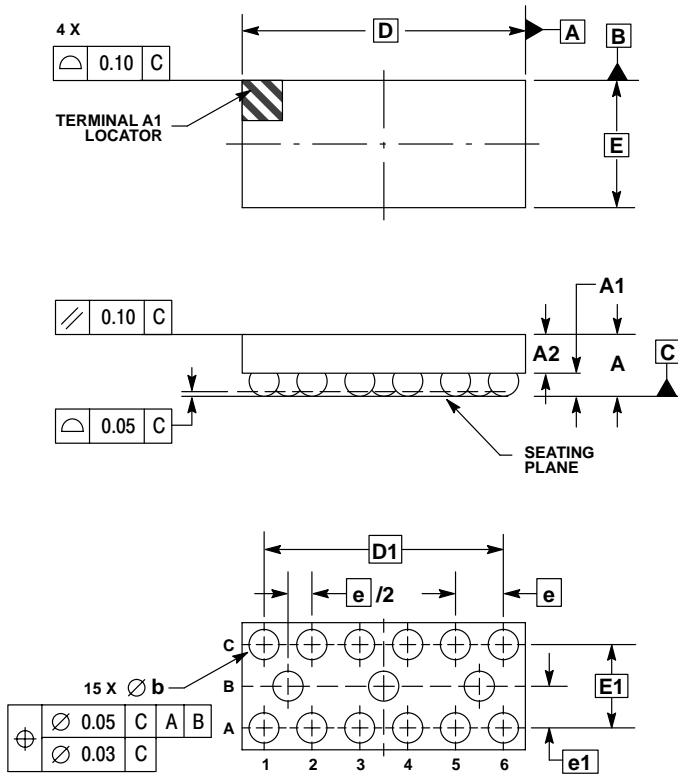

Figure 7. Solder Reflow Profile

NUF4105FC

PACKAGE DIMENSIONS

15 PIN FLIP-CHIP CSP CASE 499D-01 ISSUE O



NOTES:

1. DIMENSIONING AND TOLERANCING PER ASME Y14.5M, 1994.
2. CONTROLLING DIMENSION: MILLIMETER.
3. COPLANARITY APPLIES TO SPHERICAL CROWNS OF SOLDER BALLS.

DIM	MILLIMETERS	
	MIN	MAX
A	---	0.700
A1	0.210	0.270
A2	0.380	0.430
D	2.960	BSC
E	1.330	BSC
b	0.290	0.340
e	0.500	BSC
e1	0.435	BSC
D1	2.500	BSC
E1	0.870	BSC

NUF4105FC

ON Semiconductor and  are registered trademarks of Semiconductor Components Industries, LLC (SCILLC). SCILLC reserves the right to make changes without further notice to any products herein. SCILLC makes no warranty, representation or guarantee regarding the suitability of its products for any particular purpose, nor does SCILLC assume any liability arising out of the application or use of any product or circuit, and specifically disclaims any and all liability, including without limitation special, consequential or incidental damages. "Typical" parameters which may be provided in SCILLC data sheets and/or specifications can and do vary in different applications and actual performance may vary over time. All operating parameters, including "Typicals" must be validated for each customer application by customer's technical experts. SCILLC does not convey any license under its patent rights nor the rights of others. SCILLC products are not designed, intended, or authorized for use as components in systems intended for surgical implant into the body, or other applications intended to support or sustain life, or for any other application in which the failure of the SCILLC product could create a situation where personal injury or death may occur. Should Buyer purchase or use SCILLC products for any such unintended or unauthorized application, Buyer shall indemnify and hold SCILLC and its officers, employees, subsidiaries, affiliates, and distributors harmless against all claims, costs, damages, and expenses, and reasonable attorney fees arising out of, directly or indirectly, any claim of personal injury or death associated with such unintended or unauthorized use, even if such claim alleges that SCILLC was negligent regarding the design or manufacture of the part. SCILLC is an Equal Opportunity/Affirmative Action Employer. This literature is subject to all applicable copyright laws and is not for resale in any manner.

PUBLICATION ORDERING INFORMATION

LITERATURE FULFILLMENT:

Literature Distribution Center for ON Semiconductor
P.O. Box 61312, Phoenix, Arizona 85082-1312 USA

Phone: 480-829-7710 or 800-344-3860 Toll Free USA/Canada

Fax: 480-829-7709 or 800-344-3867 Toll Free USA/Canada

Email: orderlit@onsemi.com

N. American Technical Support: 800-282-9855 Toll Free
USA/Canada

Japan: ON Semiconductor, Japan Customer Focus Center
2-9-1 Kamimeguro, Meguro-ku, Tokyo, Japan 153-0051
Phone: 81-3-5773-3850

ON Semiconductor Website: <http://onsemi.com>

Order Literature: <http://www.onsemi.com/litorder>

For additional information, please contact your
local Sales Representative.